

Accordion Door

Yamanami



Creation of Human Space

 **Nichibei**

Line up

Creating separate spaces within a room, accordion doors are a smart choice for effective use of space. Our accordion doors are available in various models (e.g., Motorized, Curved Track, and Self-Standing models) and in various colors and styles (e.g., Washable, Skeleton, and Black-out series) to suit various applications.

Standard Model "Yamanami Mark II"

(Product Code ADM-O)



With a wide variety of color/style choices and optional extras available, this accordion door has great functionality as a partition, giving a pleasing look to the room. Featuring a high-precision hanger rail and runners, the accordion door can be opened and closed lightly, smoothly, and quietly.

- Fabric Color: 86 colors
- Available Size
Width: 54~400cm
Height: 61~280cm

Bottom Seal Model "Yamanami Down Seal"

(Product Code ADC-O)



The sealing material at the bottom is lowered and raised as the accordion door is closed and opened to prevent drafts and light from coming in.

Similar to outer coverings, the sealing material has a duplex structure, which helps achieve high sealing performance, and in turn improves the operational efficiency of your air conditioner/thermostat.

- Fabric Color: 76 colors
- Available Size
Width: 54~400cm
Height: 61~280cm



Can be completely hidden inside the door after raising when the door is open.



Can automatically be raised/lowered as the door opens/closes.



Attaches tightly to the floor as the door closes.

Economical Model “Yamanami Echo”

(Product Code ADE-O)



This accordion door is the right solution for those who look for functionality as a home partition and affordability. A wide variety of color/style options will allow you to achieve the look you want for your home.

- Fabric Color: 39 colors
- Available Size
Width: 54~300cm
Height: 61~240cm

Curved Track Model “Yamanami Curve”

(Product Code RADM-O)



This accordion door features a curved rail, which can add a wide variety of functions—for instance, creation of a small den, a space to take care of household chores, or a walk-in closet.

- Fabric Color: 86 colors
- Available Size
Width: 54~400cm
Height: 61~280cm

Auto-Close Model “Yamanami Auto-Closure”

(Product Code ADA-O)

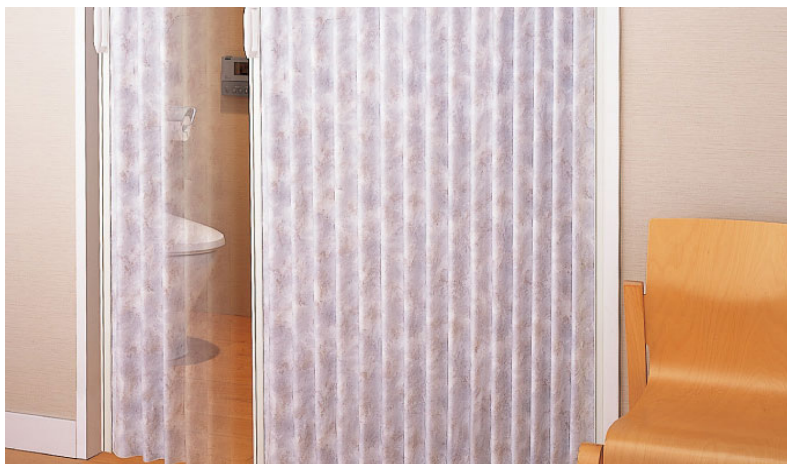

Featuring springs and oil brakes, the accordion door automatically closes.

This is perfect for installation in the kitchen, bathroom or other places where many people come and go.

- Fabric Color: 63 colors
- Available Size
Width: 54~140cm
Height: 61~280cm

Washable Model "Yamanami Wash"

(Product Code ADF-O)



Polyester-made fabrics which are detachable and machine-washable are used for this model.

- Fabric Color: 12 colors
- Available Size
Width: 54~200cm
Height: 61~280cm

Motorized Model "Yamanami Motorized"

(Product Code EAD)



This accordion door can be opened and closed smoothly by the simple press of a button. The perfect choice for hospitals and nursery facilities.

The accordion door can be switched to manual operation in the event of blackouts, motorization failures, and other events resulting in power loss.

- Fabric Color: 5 colors
- Available Size
Width: 100~212cm
Height: 161~280cm

Self-Standing Model "Yamanami Tidi"

(Product Code ADBN-R for Slim Type, ADB-R for Standard Type)



These self-standing room dividers flexibly create the right space at the right time.

Depending on your intended usage, such as covering a stock space behind a reception counter and dividing a room to create a meeting space, you can select from two different types: Slim and Standard.

- Fabric Color: 5 colors
- Available Size
Slim Type:
W=130 & 150cm, H=165cm
Standard Type:
W=150 & 180cm, H=165 & 180cm

Color Variation for Hanger Rail & Frame

For Yamanami Mark II, Down Seal, Curve, Auto-Closure, Wash

The hanger rail, frame, and handle—which have a significant impact on the overall look—are available in three colors: off-white (standard specification), light gray and dark brown.



Off-white
(standard specification)

Light gray

Dark brown

For Yamanami Echo

The hanger rail and frame are available in two colors: off-white (standard specification) and dark brown.



Off-white
(standard specification)

Dark brown

For Yamanami Tidi

Dark Brown only

For Yamanami Motorized

Off-white only

Fabric Collection

Type and Meaning of Signs applied to every fabric in the collection book.

	<p>means flame retardant fabric</p>		<p>means non-formaldehyde fabric</p>
	<p>means washable fabric</p>		<p>means super soil resistant fabric</p>

 防汚	means soil resistant fabric	 抗菌	means anti-bacterial fabric
 制電	means anti-static fabric	 防虫	means insect proof fabric
 遮光	means blackout fabric		

List of Fabric

Fabric No.	Material	Available Product Type							Features								Price Range		
		Mark II	Down Seal	Echo	Curve	Auto-Closure	Wash	Motorized	Tidi	Flame Reterdance	Non-Formaldehyde	Washable	Super Soil Resistance	Soil Resistance	Anti-Bacteria	Anti-static		Insect Proof	Blackout
L-101~112	Polyester						●			●	●	●							D
L-113~116	PVC	●			●					●	●					●	● L-116		A
L-117	PVC	●			●					●	●								A
L-118~120	PVC	●			●					●	●								A
L-121, 122	PVC	●			●					●	●								A
L-123~130	PVC	●	●	●	●	●		●		●	●			●					A
L-131~133	PVC laminated with special film	●	●		●			●		●	●		●		●				B
L-134~136	PVC	●	●		●	●		●	●	●	●			●	●				A
L-137, 138	PVC	●	●		●	●		●	●	●	●			●	●				A
L-139~141	PVC	●	●	●	●	●		●		●	●			●					A
L-142, 143	PVC	●	●	●	●	●		●		●	●			●					A
L-144, 145	PVC	●	●	●	●	●		●		●	●			●					A
L-146~148	PVC	●	●		●	●		●		●	●			●	●				A
L-149, 150	PVC	●	●		●	●		●		●	●			●	●				A
L-151~153	PVC	●	●	●	●	●		●		●	●			●					A

Fabric No.	Material	Available Product Type							Features							Price Range			
		Mark II	Down Seal	Echo	Curve	Auto-Closure	Wash	Motorized	Tidi	Flame Reterdance	Non-Formaldehyde	Washable	Super Soil Resistance	Soil Resistance	Anti-Bacteria		Anti-static	Insect Proof	Blackout
L-154~156	PVC	●	●		●	●		●		●	●			●	●				A
L-157~159	PVC	●	●		●	●		●		●	●			●	●				A
L-160, 161	PVC	●	●	●	●	●		●		●	●			●					A
L-162, 163	PVC	●	●		●	●		●		●	●			●	●				A
L-164, 165	PVC	●	●		●	●		●		●	●			●	●				A
L-166, 167	PVC	●	●		●	●		●		●	●			●	●				A
L-168, 169	PVC	●	●	●	●	●		●		●	●			●					A
L-170, 171	PVC	●	●	●	●	●		●		●	●			●					A
L-172, 173	PVC	●	●	●	●	●		●		●	●			●					A
L-174, 175	PVC laminated with special film	●	●		●			●		●	●	●		●		●			B
L-176, 177	PVC	●	●	●	●	●		●		●	●			●					A
L-178, 179	PVC	●	●	●	●	●		●		●	●			●					A
L-180, 181	PVC	●	●	●	●	●		●		●	●			●					A
L-182, 183	PVC	●	●		●	●		●		●	●			●	●				A
L-184, 185	PVC	●	●	●	●	●		●		●	●			●					A
L-186~188	PVC	●	●		●			●		●	●			●	●			●	B
L-189~191	PVC	●	●		●			●		●	●			●	●			●	B
L-192, 193	PVC	●	●		●			●		●	●			●	●			●	B
L-194~196	Olefin	●	●	●	●	●		●		●	●			●	●				C
L-197, 198	Olefin	●	●	●	●	●		●		●	●			●	●				C

Specification/Structure

■ Standard Model "Yamanami Mark II"

Unit: mm

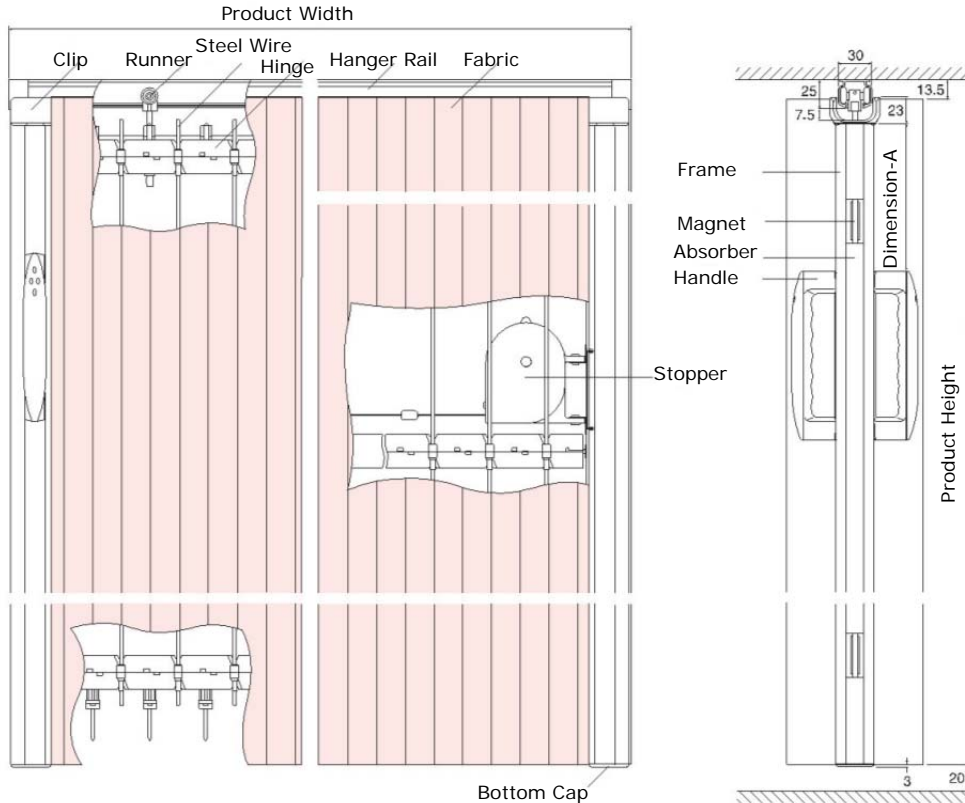

Hanger Rail

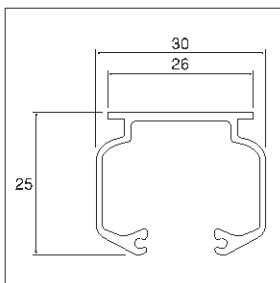

Position of Handle

Product Height (cm)	Dimension-A (cm)
61 ~ 80	20
81 ~ 100	30
101 ~ 120	45
121 ~ 140	55
141 ~ 180	60
181 ~ 200	70
201 ~ 220	80
221 ~ 240	95
241 ~ 260	110
261 ~ 280	125

- Position of Handle is adjustable.

Stacking Length

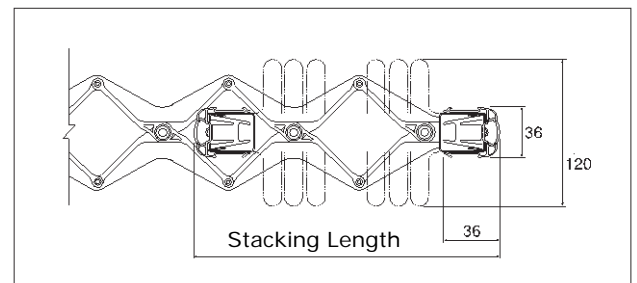

Specification

Product Name		Yamanami Mark II
Product Code		ADM-O
Available Size	Width	54~400cm
	Height	61~280cm
	Sq. m	Max. 11.2 sq.m
Fabric	Material	PVC PVC laminated with special film Olefinic resin
	Color	86 colors
Hanger Rail	Material	Aluminum alloy
	Color	Off White, Gray, Dark Brown
Frame	Material	Aluminum alloy
	Color	Off White, Gray, Dark Brown
Handle	Material	ABS resin (anti-bacterial)
	Color	Off White, Gray, Dark Brown

Stacking Length

Product Width (mm)	Stacking Length (mm)	Product Width (mm)	Stacking Length (mm)
540~620	200	2,250~2,320	476
630~680	215	2,330~2,430	490
690~770	229	2,440~2,520	505
780~860	244	2,530~2,610	519
870~950	258	2,620~2,700	534
960~1,040	273	2,710~2,790	548
1,050~1,130	287	2,800~2,910	563
1,140~1,230	302	2,920~3,000	577
1,240~1,320	316	3,010~3,090	591
1,330~1,410	331	3,100~3,180	606
1,420~1,510	345	3,190~3,270	620
1,520~1,600	360	3,280~3,370	635
1,610~1,690	374	3,380~3,460	649
1,700~1,780	389	3,470~3,560	664
1,790~1,870	403	3,570~3,640	678
1,880~1,960	418	3,650~3,730	693
1,970~2,050	432	3,740~3,820	707
2,060~2,150	447	3,830~3,910	722
2,160~2,240	461	3,920~4,000	736

Bottom Seal Model "Yamanami Down Seal"

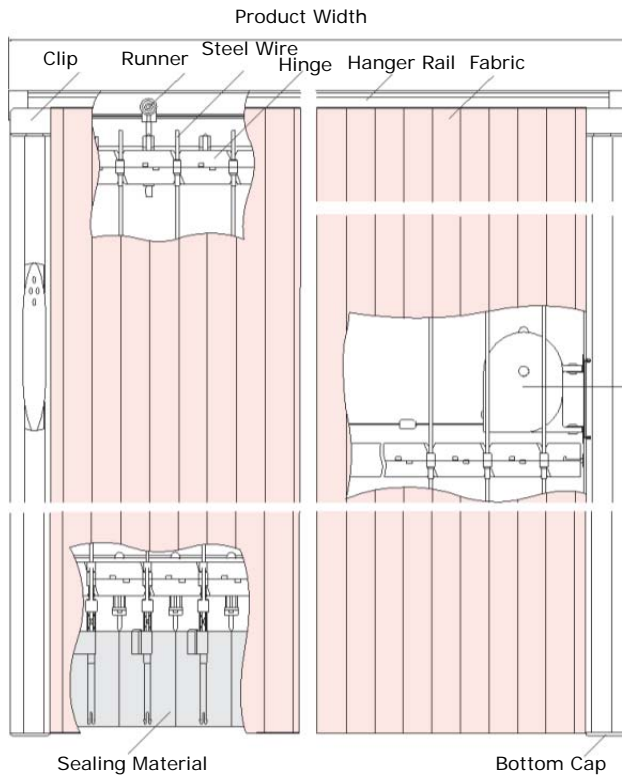

Unit: mm

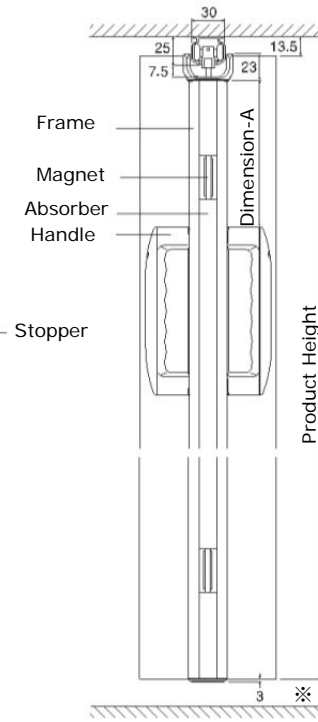

※Sealing Material drops more than 2cm.

Hanger Rail

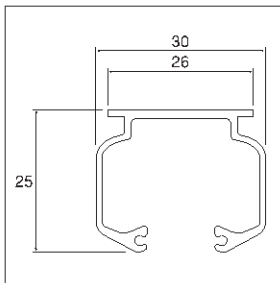

Position of Handle

Product Height (cm)	Dimension-A (cm)
61 ~ 80	20
81 ~ 100	30
101 ~ 120	45
121 ~ 140	55
141 ~ 180	60
181 ~ 200	70
201 ~ 220	80
221 ~ 240	95
241 ~ 260	110
261 ~ 280	125

● Position of Handle is adjustable.

Stacking Length

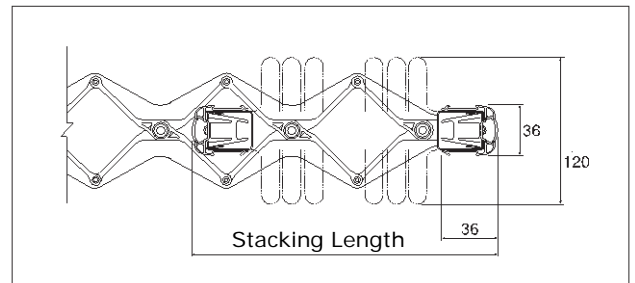

Specification

Product Name		Yamanami Down Seal
Product Code		ADC-O
Available Size	Width	54~400cm
	Height	61~280cm
	Sq. m	Max. 11.2 sq.m
Fabric	Material	PVC
		PVC laminated with special film Olefinic resin
Hanger Rail	Material	Aluminum alloy
	Color	Off White, Gray, Dark Brown
Frame	Material	Aluminum alloy
	Color	Off White, Gray, Dark Brown
Handle	Material	ABS resin (anti-bacterial)
	Color	Off White, Gray, Dark Brown
Sealing Material	Material	PVC sheet & Cotton
	Color	Off White, Gray, Dark Brown

Stacking Length

Product Width (mm)	Stacking Length (mm)	Product Width (mm)	Stacking Length (mm)
540~620	200	2,250~2,320	476
630~680	215	2,330~2,430	490
690~770	229	2,440~2,520	505
780~860	244	2,530~2,610	519
870~950	258	2,620~2,700	534
960~1,040	273	2,710~2,790	548
1,050~1,130	287	2,800~2,910	563
1,140~1,230	302	2,920~3,000	577
1,240~1,320	316	3,010~3,090	591
1,330~1,410	331	3,100~3,180	606
1,420~1,510	345	3,190~3,270	620
1,520~1,600	360	3,280~3,370	635
1,610~1,690	374	3,380~3,460	649
1,700~1,780	389	3,470~3,560	664
1,790~1,870	403	3,570~3,640	678
1,880~1,960	418	3,650~3,730	693
1,970~2,050	432	3,740~3,820	707
2,060~2,150	447	3,830~3,910	722
2,160~2,240	461	3,920~4,000	736

■ Economical Model “Yamanami Echo”

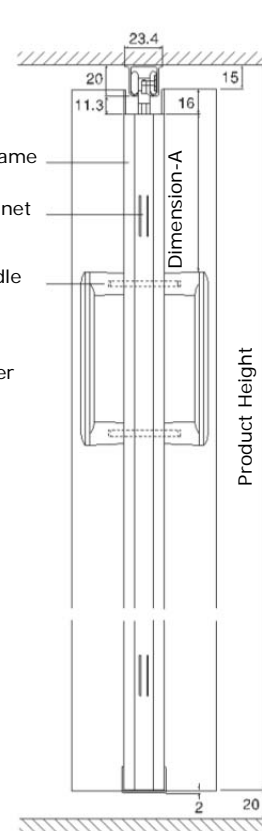
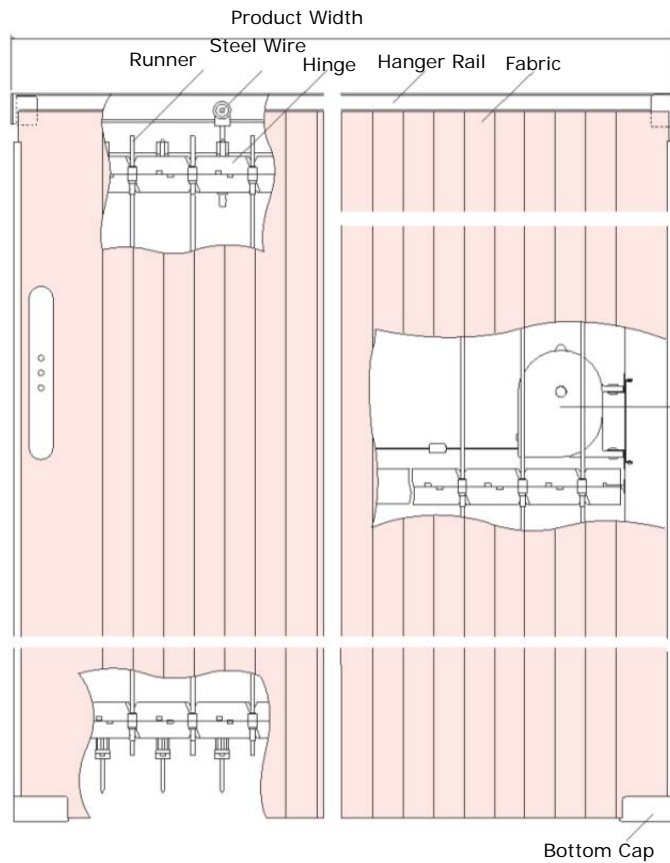

Unit: mm

Hanger Rail

Position of Handle

Stacking Length

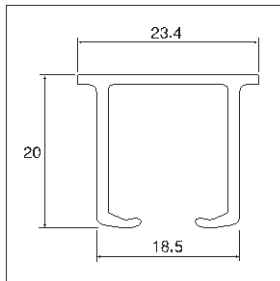

Product Height (cm)	Dimension-A (cm)
61 ~ 80	20
81 ~ 100	30
101 ~ 120	45
121 ~ 140	55
141 ~ 180	60
181 ~ 200	70
201 ~ 220	80
221 ~ 240	95

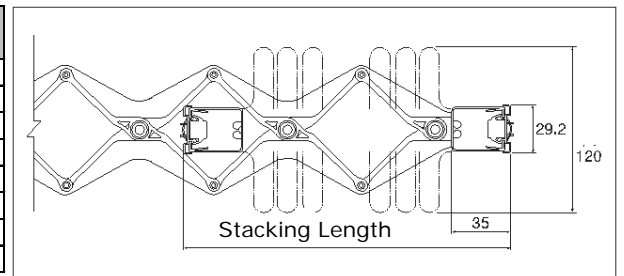

Specification

Product Name		Yamanami Echo
Product Code		ADE-O
Available Size	Width	54~300cm
	Height	61~240cm
	Sq. m	Max. 7.2 sq.m
Fabric	Material	PVC
		Olefinic resin
	Color	39 colors
Hanger Rail	Material	Aluminum alloy
	Color	Off White, Dark Brown
Frame	Material	Aluminum alloy
	Color	Off White, Dark Brown
Handle	Material	ABS resin (anti-bacterial)
	Color	Off White, Dark Brown

Stacking Length

Product Width (mm)	Stacking Length (mm)	Product Width (mm)	Stacking Length (mm)
540~620	190	2,250~2,320	465
630~680	204	2,330~2,430	480
690~770	219	2,440~2,520	494
780~860	233	2,530~2,610	509
870~950	248	2,620~2,700	523
960~1,040	262	2,710~2,790	538
1,050~1,130	277	2,800~2,910	552
1,140~1,230	291	2,920~3,000	567
1,240~1,320	306		
1,330~1,410	320		
1,420~1,510	335		
1,520~1,600	349		
1,610~1,690	364		
1,700~1,780	378		
1,790~1,870	393		
1,880~1,960	407		
1,970~2,050	422		
2,060~2,150	436		
2,160~2,240	451		

■ Curved Track Model “Yamanami Curve”

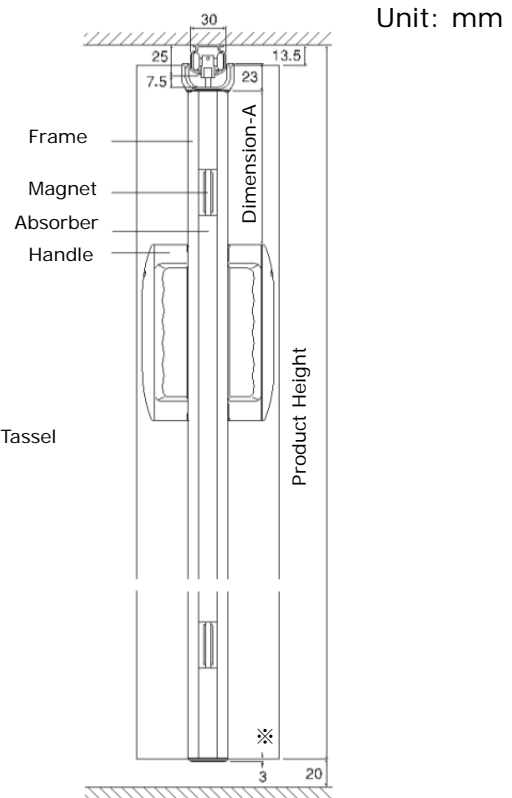
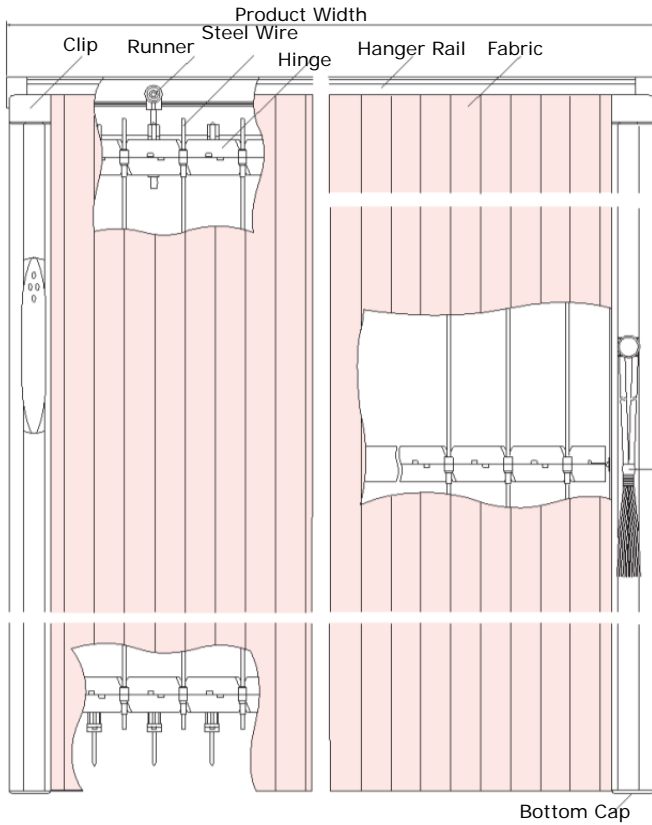

Hanger Rail

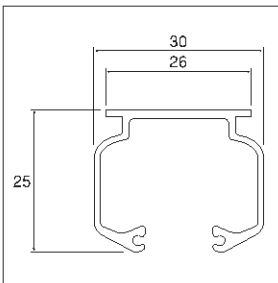

Position of Handle

Product Height (cm)	Dimension-A (cm)
61 ~ 80	20
81 ~ 100	30
101 ~ 120	45
121 ~ 140	55
141 ~ 180	60
181 ~ 200	70
201 ~ 220	80
221 ~ 240	95
241 ~ 260	110
261 ~ 280	125

● Position of Handle is adjustable.

Stacking Length

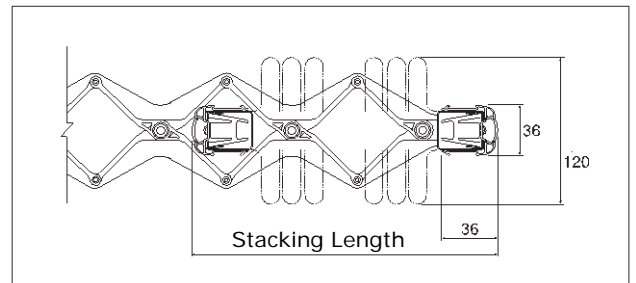

Specification

Product Name		Yamanami Curve
Product Code		RADM-O
Available Size	Width	54~400cm
	Height	61~280cm
	Sq. m	Max. 11.2 sq.m
Fabric	Material	PVC PVC laminated with special film Olefinic resin
	Color	86 colors
	Hanger Rail	Material: Aluminum alloy Color: Off White, Gray, Dark Brown
Frame	Material: Aluminum alloy Color: Off White, Gray, Dark Brown	
Handle	Material	ABS resin (anti-bacterial)
	Color	Off White, Gray, Dark Brown

Stacking Length

Product Width (mm)	Stacking Length (mm)	Product Width (mm)	Stacking Length (mm)
540~620	304	2,250~2,320	534
630~680		2,330~2,430	
690~770		2,440~2,520	
780~860	334	2,530~2,610	554
870~950		2,620~2,700	
960~1,040		2,710~2,790	
1,050~1,130	354	2,800~2,910	604
1,140~1,230		2,920~3,000	
1,240~1,320		3,010~3,090	
1,330~1,410	384	3,100~3,180	654
1,420~1,510		3,190~3,270	
1,520~1,600		3,280~3,370	
1,610~1,690	434	3,380~3,460	704
1,700~1,780		3,470~3,560	
1,790~1,870		3,570~3,640	
1,880~1,960	454	3,650~3,730	744
1,970~2,050		3,740~3,820	
2,060~2,150		3,830~3,910	
2,160~2,240	504	3,920~4,000	774

Product Width = L1 + L2

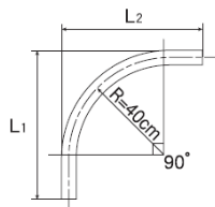

■ Auto-Close Model “Yamanami Auto-Closure”

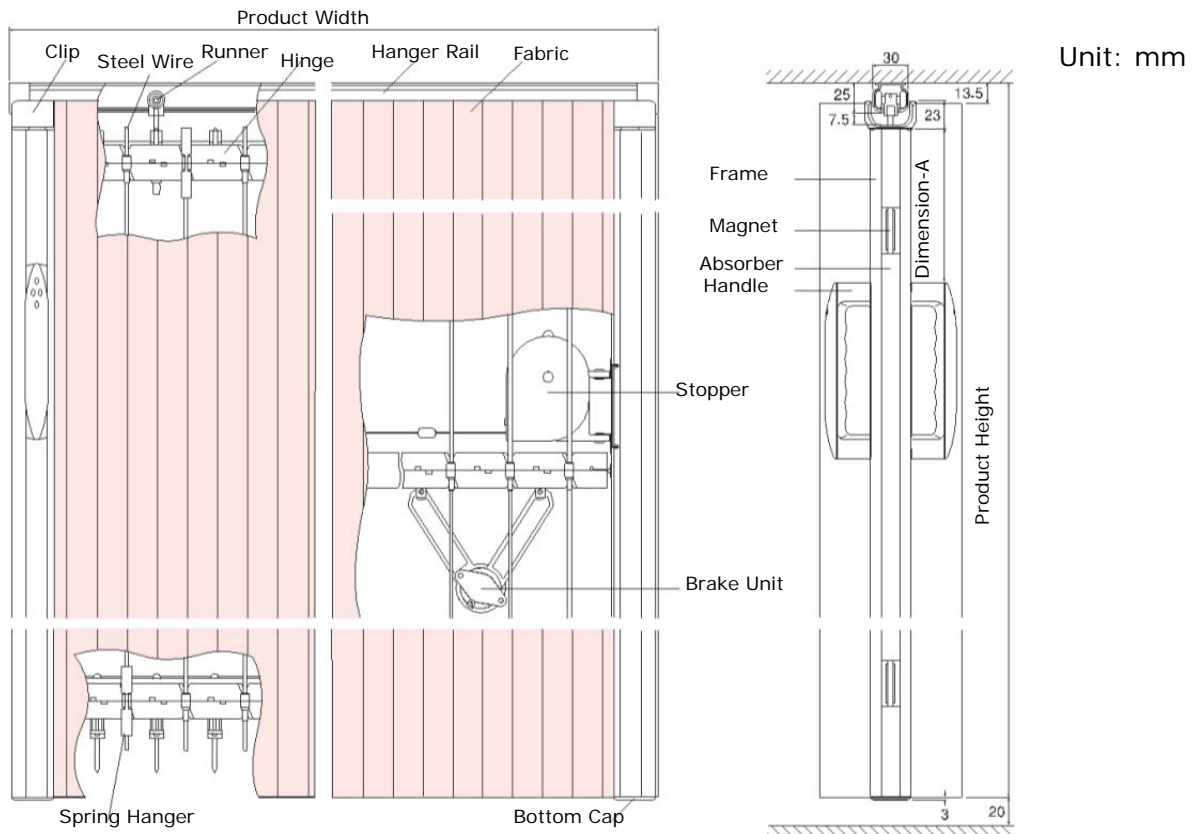

Hanger Rail

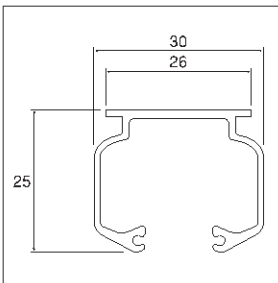

Position of Handle

Product Height (cm)	Dimension-A (cm)
61 ~ 80	20
81 ~ 100	30
101 ~ 120	45
121 ~ 140	55
141 ~ 180	60
181 ~ 200	70
201 ~ 220	80
221 ~ 240	95
241 ~ 260	110
261 ~ 280	125

● Position of Handle is adjustable.

Stacking Length

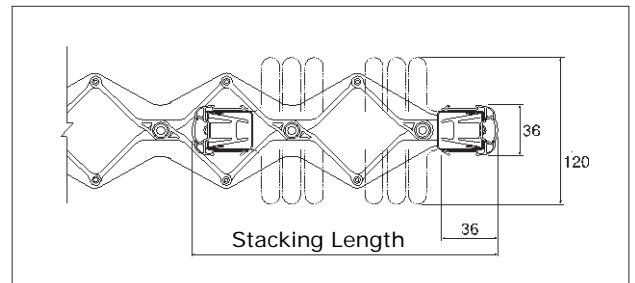

Specification

Product Name	Yamanami Auto-Closure	
Product Code	ADA-O	
Available Size	Width	54~140cm
	Height	61~280cm
	Sq. m	Max. 3.92 sq.m
Fabric	Material	PVC Olefinic resin
	Color	63 colors
Hanger Rail	Material	Aluminum alloy
	Color	Off White, Gray, Dark Brown
Frame	Material	Aluminum alloy
	Color	Off White, Gray, Dark Brown
Handle	Material	ABS resin (anti-bacterial)
	Color	Off White, Gray, Dark Brown

Stacking Length

Product Width (mm)	Stacking Length (mm)
540~620	200
630~680	215
690~770	229
780~860	244
870~950	258
960~1,040	273
1,050~1,130	287
1,140~1,230	302
1,240~1,320	316
1,330~1,400	331

■ Washable Model “Yamanami Wash”

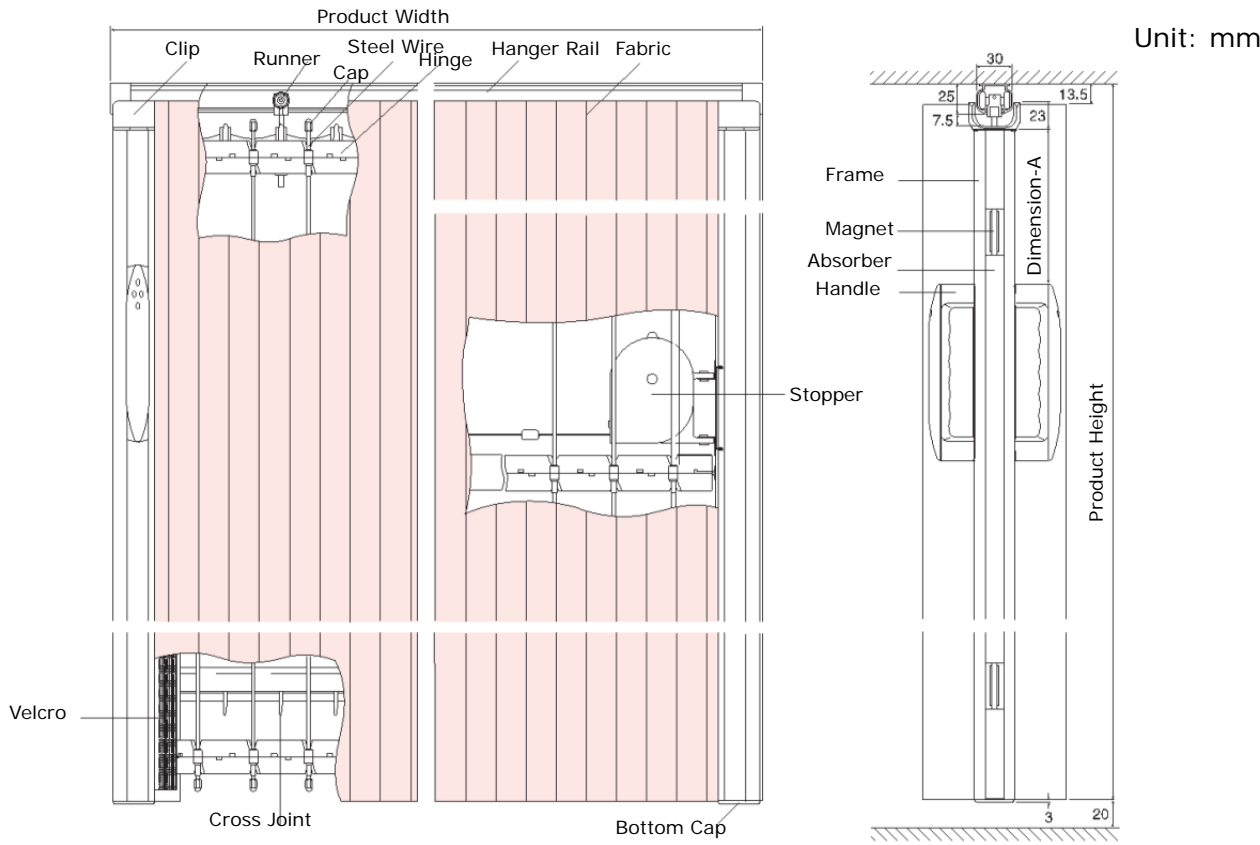

Hanger Rail

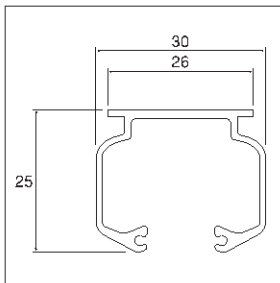

Position of Handle

Product Height (cm)	Dimension-A (cm)
61 ~ 80	20
81 ~ 100	30
101 ~ 120	45
121 ~ 140	55
141 ~ 180	60
181 ~ 200	70
201 ~ 220	80
221 ~ 240	95
241 ~ 260	110
261 ~ 280	125

● Position of Handle is adjustable.

Stacking Length

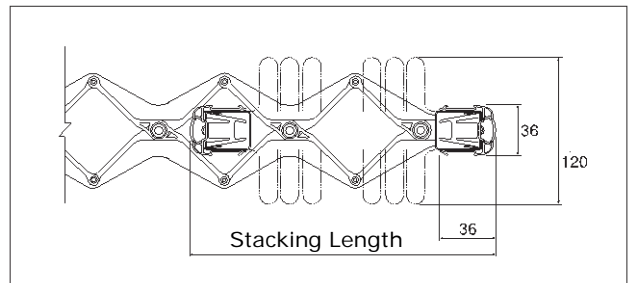

Specification

Product Name	Yamanami Wash	
Product Code	ADF-O	
Available Size	Width	54~200cm
	Height	61~280cm
	Sq. m	Max. 5.6 sq.m
Fabric	Material	Polyester
	Color	12 colors
Hanger Rail	Material	Aluminum alloy
	Color	Off White, Gray, Dark Brown
Frame	Material	Aluminum alloy
	Color	Off White, Gray, Dark Brown
Handle	Material	ABS resin (anti-bacterial)
	Color	Off White, Gray, Dark Brown

Stacking Length

Product Width (mm)	Stacking Length (mm)
540~620	200
630~680	215
690~770	229
780~860	244
870~950	258
960~1,040	273
1,050~1,130	287
1,140~1,230	302
1,240~1,320	316
1,330~1,410	331
1,420~1,510	345
1,520~1,600	360
1,610~1,690	374
1,700~1,780	389
1,790~1,870	403
1,880~1,960	418
1,970~2,000	432

Motorized Model "Yamanami Motorized"

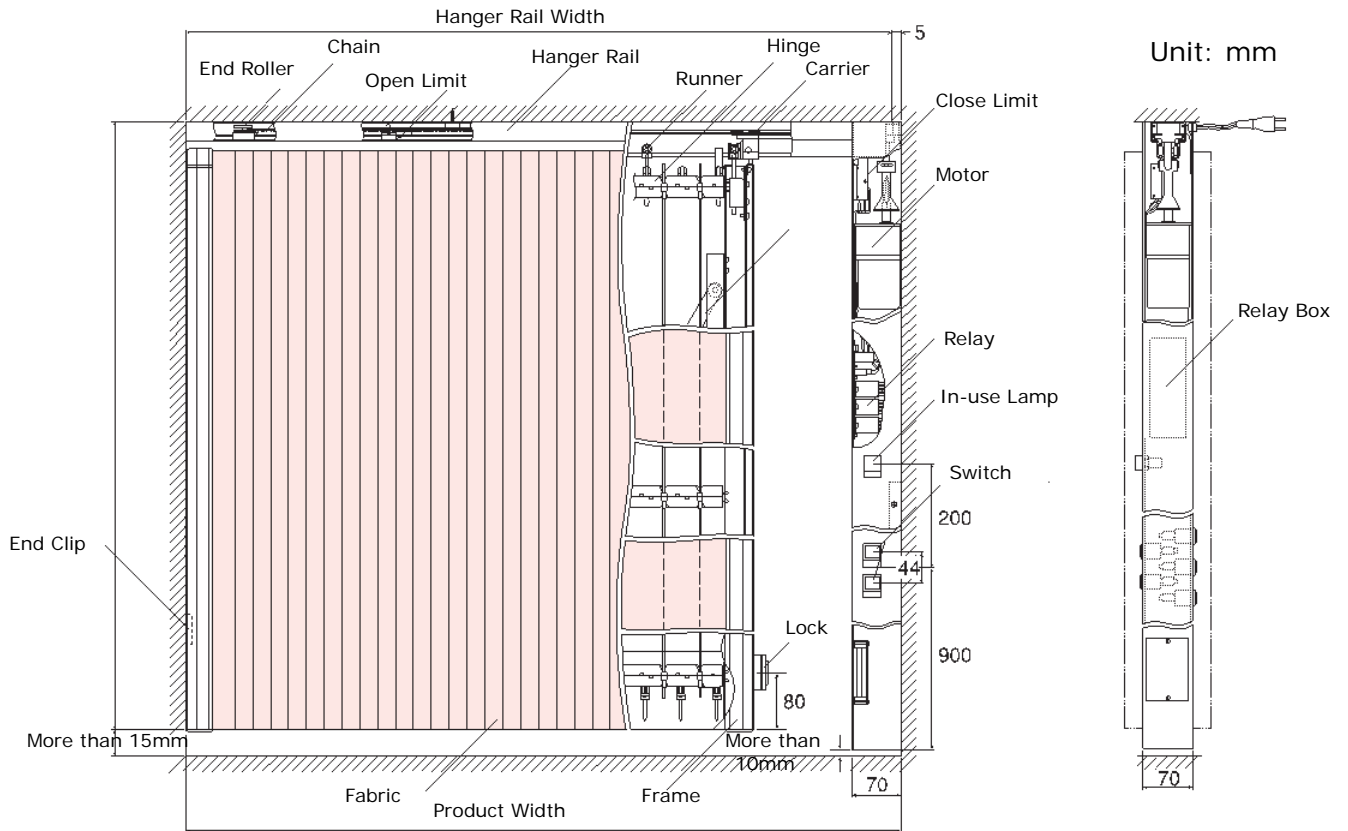

Hanger Rail

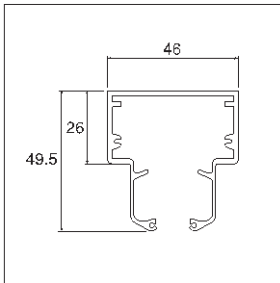

Electric Box

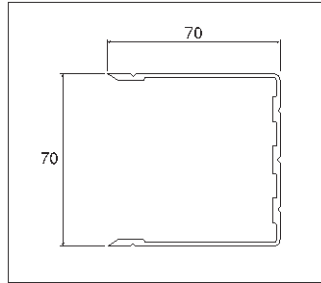

Stacking Length

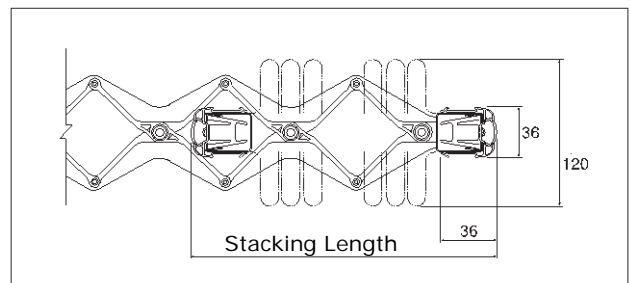

Specification

Product Name		Yamanami Motorized
Product Code		EAD
Available Size	Width	100~212cm
	Height	161~280cm
	Sq. m	Max. 5.9 sq.m
Fabric	Material	PVC PVC laminated with special film Olefinic resin
	Color	76 colors
Hanger Rail	Material	Aluminum alloy
	Color	Off White
Frame	Material	Aluminum alloy
	Color	Off White

Stacking Length

Product Width (mm)	Stacking Length (mm)
1,000~1,020	290
1,030~1,110	305
1,120~1,200	320
1,210~1,300	350
1,310~1,390	365
1,400~1,480	380
1,490~1,580	395
1,590~1,670	410
1,680~1,760	440
1,770~1,850	455
1,860~1,940	470
1,950~2,030	485
2,040~2,120	500

Specification of Motor

Voltage/Frequency	AC100V 50/60Hz
Rated Current	0.5/0.5A
Output Shaft Speed	127/156rpm
Output Shaft Torque	0.67/0.56Nm
Rated Time	5 minutes

Self-Standing Model "Yamanami Tidi"

Unit: mm

Slim Type

Straight Model

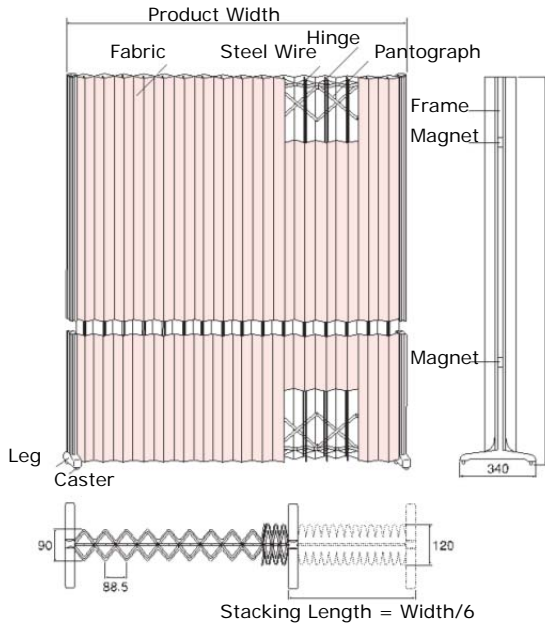

L-shaped Model

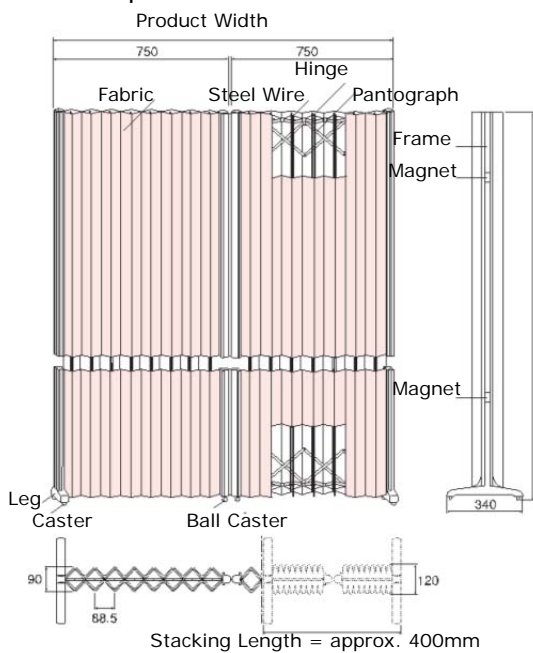

Standard Type

Straight Model

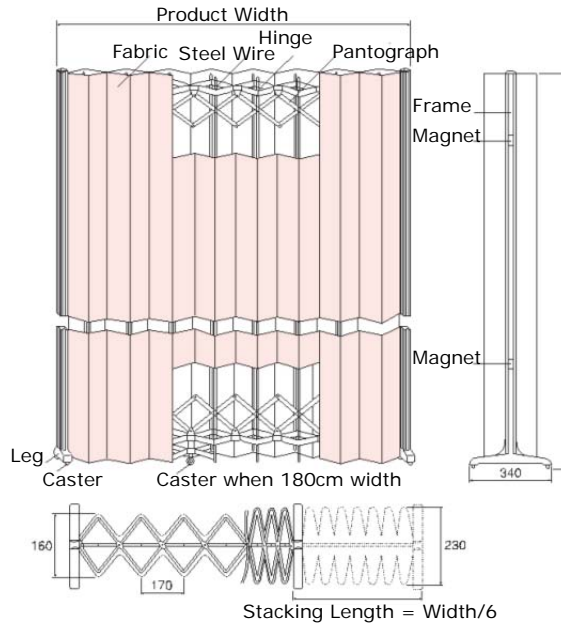

L-shaped Model

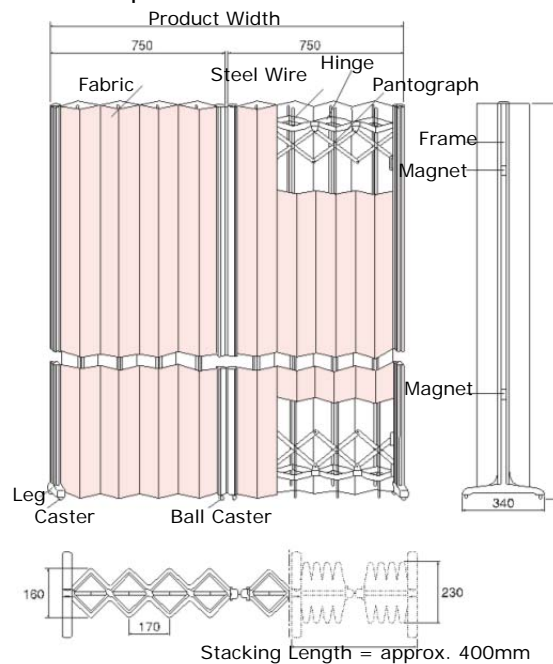

Product Name		Yamanami Tidi Slim Type	
Product Code		ADB-N-R	
Model		Straight Model	L-shaped Model
Available Size	Width	130 & 150cm	150cm (75 + 75cm)
	Height	165cm	
Fabric	Material	PVC	
	Color	5 colors	
Frame	Material	Aluminum alloy	
	Color	Dark Brown	

Product Name		Yamanami Tidi Standard Type	
Product Code		ADB-R	
Model		Straight Model	L-shaped Model
Available Size	Width	150 & 180cm	150cm (75 + 75cm)
	Height	165 & 1870cm	
Fabric	Material	PVC	
	Color	5 colors	
Frame	Material	Aluminum alloy	
	Color	Dark Brown	

Option

■ Hanger Pipe and Wall Bracket

Available for Yamanami Mark II, Down Seal, Curve, Auto-Closure and Wash



Hanger Pipe



Off-White



Gray



Dark Brown

Wall Bracket

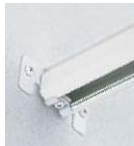

Off-White



Gray



Dark Brown

Available for Yamanami Echo

Hanger Pipe



Wall Bracket



■ Top Bracket

Available for Yamanami Mark II, Down Seal, Echo, Curve, Auto-Closure and Wash



Off-White

Gray

Dark Brown

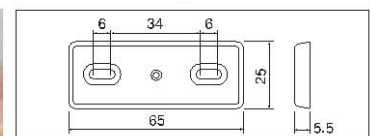

■ Rail Joint Bracket (with Joint Pin)

Available for Yamanami Mark II, Down Seal, Curve, Auto-Closure and Wash

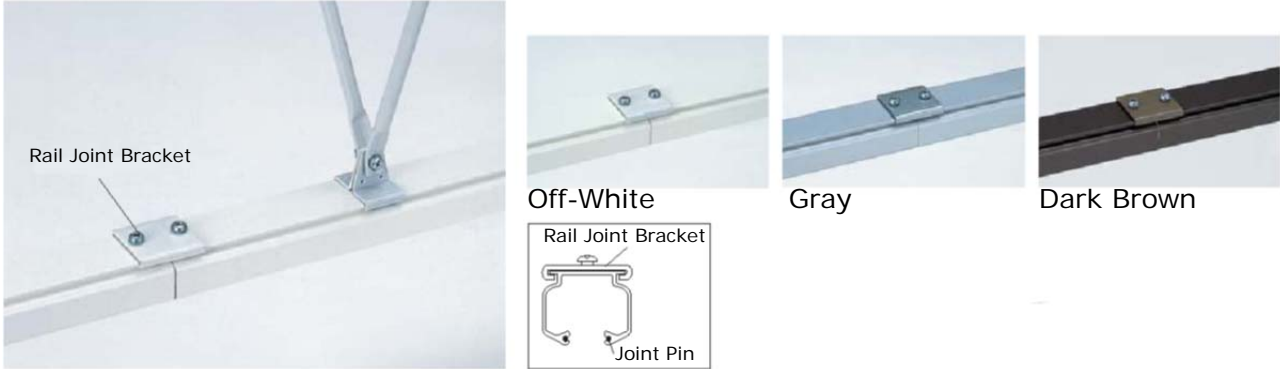

■ End Clip

Available for Yamanami Mark II, Down Seal, Curve, Auto-Closure and Wash



Available for Yamanami Echo



■ Center Stopper

Available for Yamanami Mark II, Down Seal, Curve, Auto-Closure and Wash



Available for Yamanami Echo

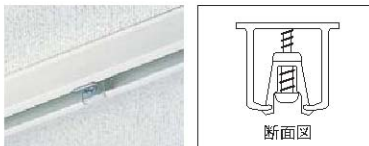

■ Side Stopper

Available for Yamanami Mark II, Down Seal, Curve, Auto-Closure and Wash



Available for Yamanami Echo



■ Wall Frame

Available for Yamanami Mark II, Down Seal, Echo, Curve, Auto-Closure and Wash

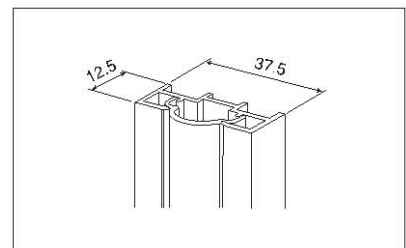

L=2500mm & 3000mm

■ Bar & Post

Available for Yamanami Mark II, Down Seal, Echo, Auto-Closure and Wash



Bar: used when the ceiling is not strong enough or is made of concrete
 Post: used when the wall is not flat.



Off-White

Gray

Dark Brown

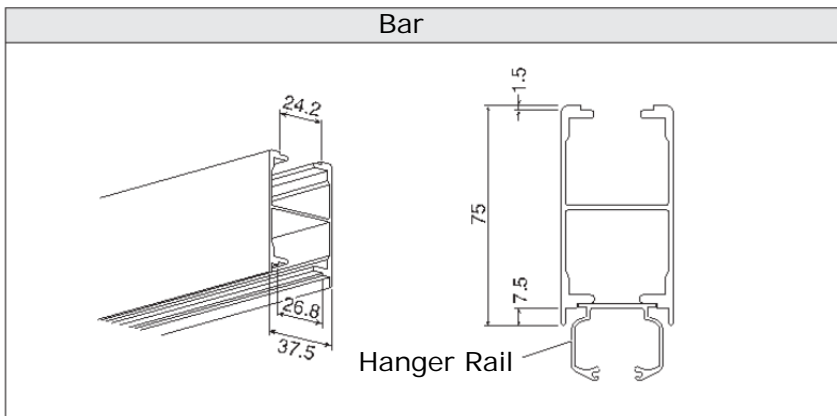

L=1900mm, 2800mm and 4000mm

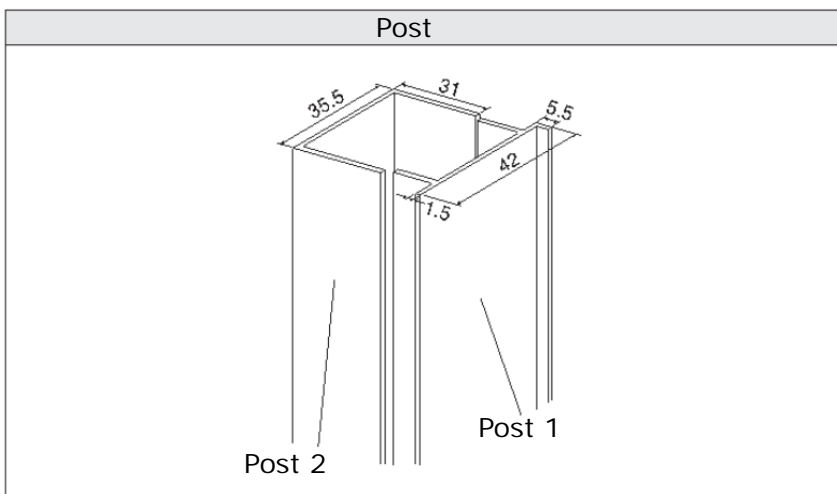

L=2500mm and 3000mm

Special Arrangement

■ Dou-Tone

Available for Yamanami Mark II, Down Seal, Curve and Auto-Closure

Different fabric is put on every face.



■ Upper Transparent

Available for Yamanami Mark II, Down Seal and Curve

To get light in the room.



300mm type

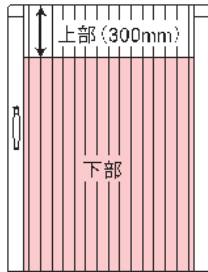

600mm type

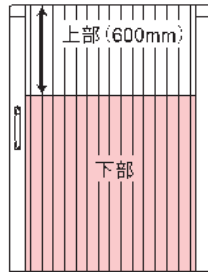

■ Inside Mount

Available for Yamanami Mark II, Down Seal, Curve and Auto-Closure

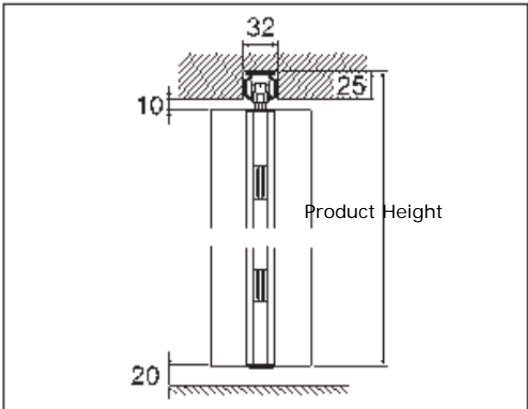

■ Double Handle

Available for Yamanami Mark II, Down Seal, Echo, Curve and Wash

Handle is put on both right and left side.

■ Cylinder Lock

Available for Yamanami Mark II, Down Seal, Curve, Auto-Closure and Wash



Room Side

Outside

■ Slide Lock

Available for Yamanami Mark II, Down Seal, Curve, Auto-Closure and Wash



Room Side

Outside

Red: locked

■ Lever Lock

Available for Yamanami Mark II, Down Seal, Curve, Auto-Closure and Wash



Room Side

Outside

Room Side

Outside

Outside
Blue: released
Red: locked